

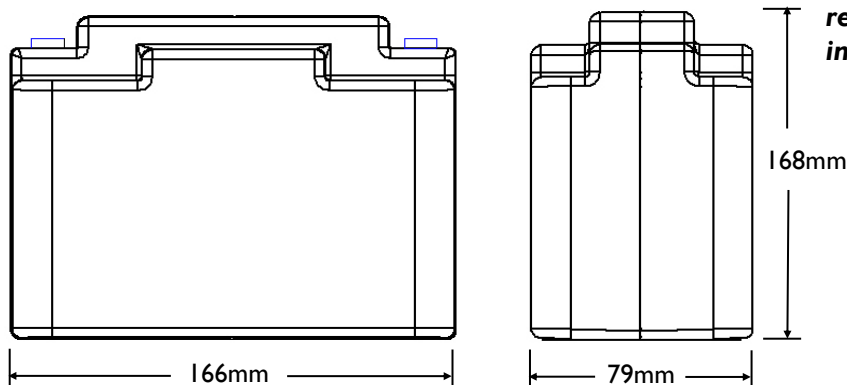

DIMENSIONS

Brass terminal: 12mm wide, 3mm high

Screws: M6 (6mm dia., 10mm length)



**Lightweight LiFePO4 battery with exclusive over discharge protection, over charge protection, short circuit protection, excessive cranking protection and built in cell balancing technology. All of these features are redundant with an LED battery fault light indicator.**



SPECIFICATIONS

## Specifications

Voltage	13.2V
Capacity	24.8Ah (See charts)
Capacity vs Temperature	25 °C = 100% 0°C = 92% -30°C = 80%
Self-Discharge Rate	< 3% / month @ 25 °C
Pulse Crank Amps (PCA)	1200A (3 sec @ 25 °C, voltage >9V)
Cold Crank Amps (CCA)	600A (modified SAE test, 3 sec@ 0°F, volts >7.2V)
Continuous Discharge Amps	150A
Standard Charge Voltage	13.9 - 14.6 V
Maximum Charge Voltage	15V
Recommended Charge Amps	5 - 25A
Max Charge Amps	120A (from vehicle charging system)
Life (Charge cycles, 80% depth of discharge)	4000 cycles @ 1C discharge rate, 25°C 2000 cycles @ 10C discharge rate, 25°C
Life (Years)	Up to 8 Years
Weight	6.9 lb. (3.1Kg)
Dimensions	6.5 in (L) x 3.1 in (W) x 6.6 in (H) 166mm(L) x 79mm (W) x 168mm (H)
Environmental Rating (resistance to water intrusion)	IP 66 (wash down with a high pressure washer)
Operating Temperature	-30 °C to +60 °C
Storage Temperature	-40 °C to +70 °C

## Discharge Characteristics

Discharge Ah (multiple discharge rates)

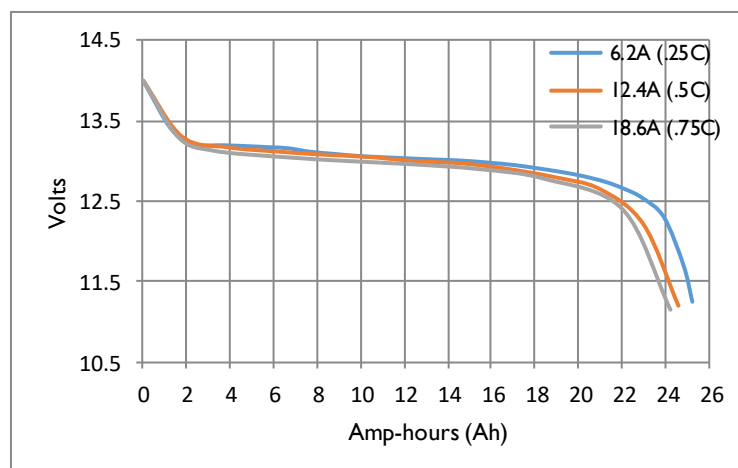

Discharge Minutes (multiple discharge rates)

